

XT Series DD Servo Motors

XT系列直驱力矩电机

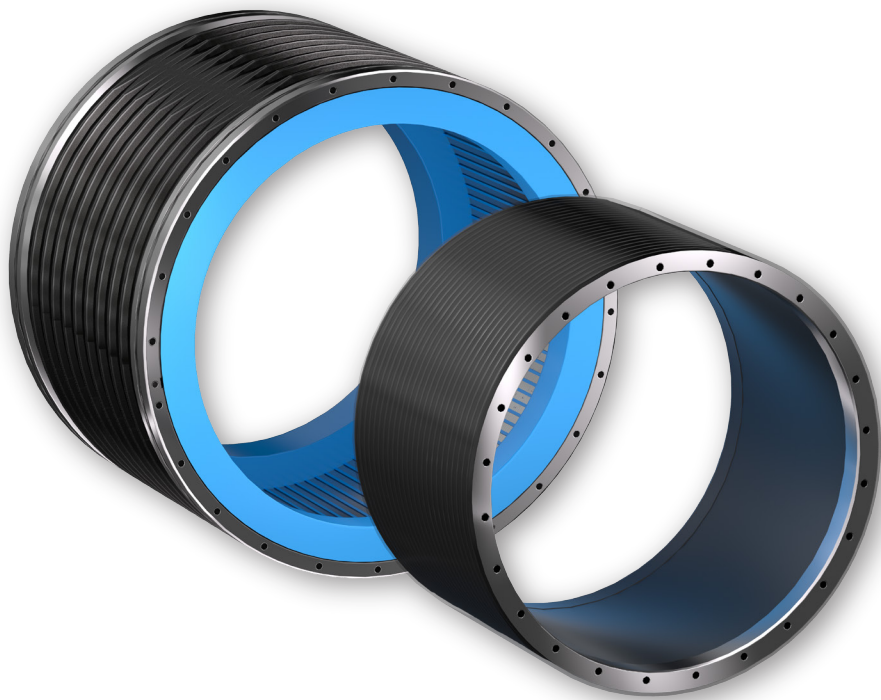



Company Profile 企业简介

宁波菲仕技术股份有限公司（简称：菲仕技术）成立于 2001 年，由民营控股、先进制造产业投资基金和宁波和丰创业投资有限公司等战略投资人参股，公司致力于以电驱动技术为核心的创新及产业化，为运动控制和能量转换领域提供系统产品和综合解决方案，经过多年的品牌沉淀，菲仕已成为一家集研发、生产、销售为一体，拥有国内外多家控股子公司的集团化创新型高科技企业。

Ningbo Physis Technology Co., Ltd. was founded in 2001, which is a private enterprise holding group company, invested by Advanced Manufacturing Fund and Ningbo Hefeng Venture Capital Co., Ltd. Physis always devotes to innovation and industrialization of electrical drive technology, provides servo products and solutions for the field of motion control & energy conversion. After years of brand development and accumulation, Physis became a collectivized & innovative high-tech enterprise, which collects together research and development (R&D), production and sale, has a numbers of domestic and overseas subsidiaries.

R&D Team 研发团队

在智能制造全球化的趋势中，菲仕逐步落地国际化的战略布局，在欧洲成立了研发中心，与国内外专业科研机构、专家合作，进行定期交流和互动，以保持公司持续站立在伺服系统科技创新的最前沿，共同推进产业发展。经过多年的沉淀，顶尖人才的积累，菲仕在国内拥有省级工程技术中心、省级高新技术企业研究开发中心，并入选了国家工信部第一批专精特新“小巨人”企业！

3 个
研发中心

4 个
生产基地

300 +
研发团队

350 +
授权专利

In the globalization tendency of intelligent manufacture, Physis implements the strategic layout of the group internationalization gradually, builds the R&D center in Europe, communicate and interact regularly with the world-class scientific research institution & industry experts, which makes Physis hold on the lead of the servo system technology innovation and promote industrial development together! After years of development, accumulation of talents, Physis has provincial engineering & technology center and more than 200 people of R&D team. Until now, Physis has more than 300 patents.

CONTENTS 目录

产品特点 Product Features	01
应用领域 Application	02
XT 系列伺服电机代码 Servo Motor Code	02
XT210	03
XT295	05
XT360	07
XT450	09
XT530	11
XT760	13
XT990	15
XT1220	17
联系我们 Contact Information	19

Product Features

产品特点

高功率密度

XT 系列通过新工艺线圈排布技术，大幅提升了槽满率，使得电机在扭矩密度达到行业领先水平。

强工艺技术

采用先进的真空环氧浇注工艺，并辅以独特的冷却结构设计。这一组合不仅显著增强了电机的散热性能，提高了绝缘等级，还大大增强了电机的结构稳定性，确保电机在长时间、高负荷运行下的可靠性。

紧凑设计

电机结构紧凑，无框设计便于集成在 A 轴、B 轴、C 轴内部，适应各种空间紧凑、高扭矩的严苛应用场景，方便安装与维护。

系列化全面覆盖

该系列电机定子外径范围覆盖 210mm ~ 1220mm，扭矩范围从 60 牛米扩展至 5 万牛米。广泛适用于机床行业的五轴机床、直驱摇篮转台和直驱摆头等高性能需求的应用场合，为现代工业制造提供了强有力的动力支持。

High Power Density: The XT series, through innovative coil arrangement technology, has significantly increased the slot fill rate, allowing the motor to achieve industry-leading levels of torque density.

Robust Craftsmanship: Utilizing advanced vacuum epoxy pouring techniques, complemented by a unique cooling structure design. This combination not only significantly enhances the motor's heat dissipation capabilities and insulation level but also greatly strengthens the structural stability of the motor, ensuring reliability during long periods of high-load operation.

Compact Design: The motor features a compact structure with a frameless design that facilitates integration within the A-axis, B-axis, C-axis, adapts to various space-constrained, high-torque demanding application scenarios, and simplifies installation and maintenance.

standardization & serialization: This series of motors covers a stator outer diameter range from 210mm to 1220mm, with torque ranging from 60 Nm to 50,000 Nm. It is widely applicable to high-performance requirements in the machine tool industry, such as five-axis machine tools, direct-drive cradle rotary tables, and direct-drive swing heads, providing robust power support for modern industrial manufacturing.

全新磁路设计 New Magnetic Circuit Design

结构更紧凑
More compact
structure

环氧封装 Epoxy Encapsulation

绝缘性更高
Higher
insulation

碳纤维 Carbon Fiber

安全运行
整机轻量化
Safe operation
Overall weight
reduction

水冷结构 Water Cooling Structure

散热性能更强
Stronger heat
dissipation
performance

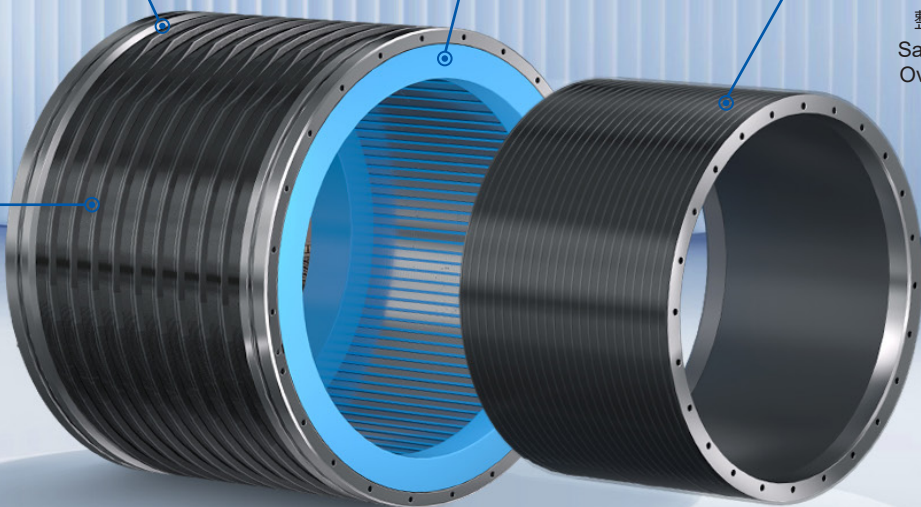

Application 应用领域

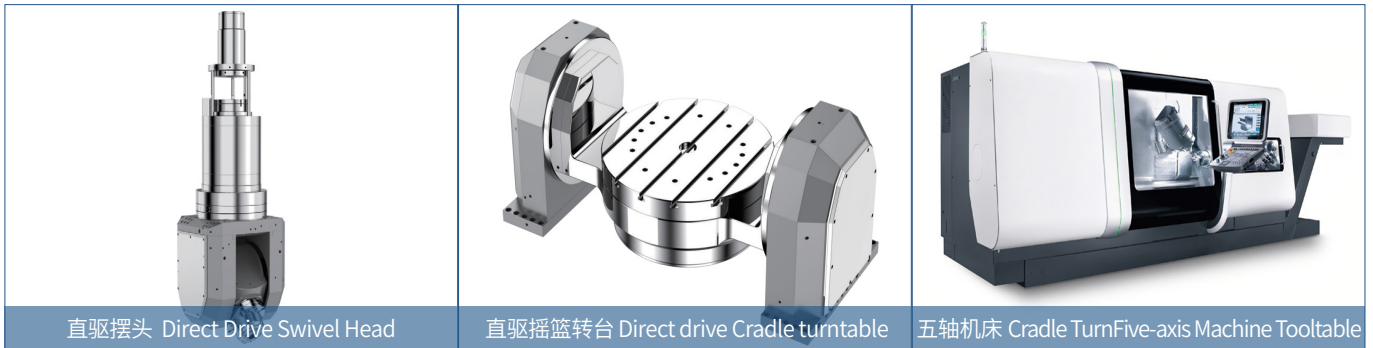

Servo Motor Code XT 系列伺服电机代码

XT - 360 - 070 - 000C

集中绕组
电机代码

Concentrated
Winding
Motor Coding

电机底座识别：
电机定子外径 (mm)
210、295、360、450

Machine base
identification:
Motor stator outer
diameter (mm)
210、295、360、450

电机高度识别：
定子冲片叠厚度 (mm)
30、50、70、100、
150、200

Motor height
identification: Stator
lamination stack
thickness (mm)
30、50、70、100、
150、200

标准款电机代码

Standard motor code

订购代码示例：

XT360-070-000C

定子外径 360mm，叠厚 70mm 的标准款集中绕组力矩电机

Order Code Example:

XT360-070-000C

The outer diameter of the stator is 360mm, and the stacking thickness is 70mm

XT210

性能参数 Performance parameters

电机型号 Motor Code	额定转速 wn	峰值转速 wmax	额定电流 In	额定扭矩 Tn	额定功率 Pn	最大电流 Imax	最大转矩 Tmax
	[rpm]	[rpm]	[A]	[Nm]	[kW]	[A]	[Nm]
XT210-030-000C	100	200	3.5	60	0.6	6.5	110
XT210-050-000C	100	200	5.1	100	1.0	10.2	200
XT210-070-000C	100	200	7.0	145	1.5	14.2	290
XT210-100-000C	100	200	10.2	200	2.1	21.0	400
XT210-150-000C	100	200	14.0	320	3.4	29.0	640
XT210-200-000C	100	200	20.5	420	4.4	43.0	850

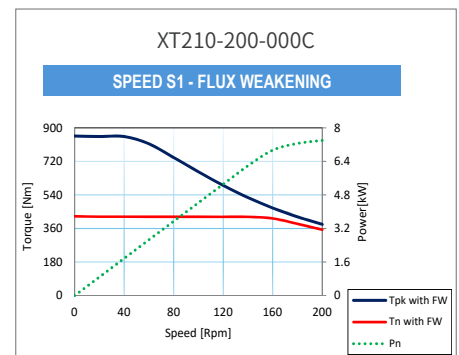
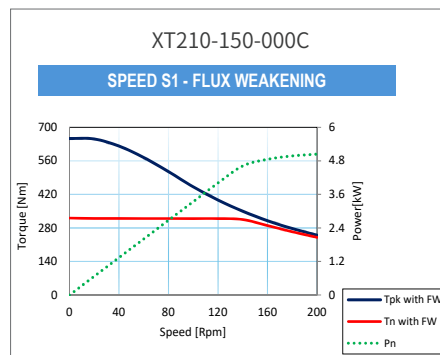
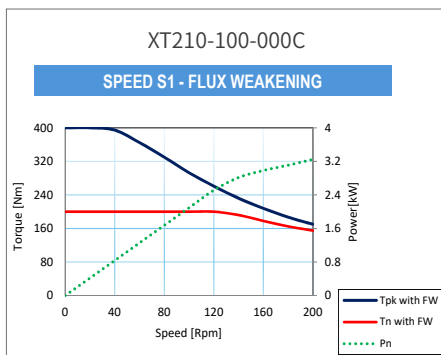
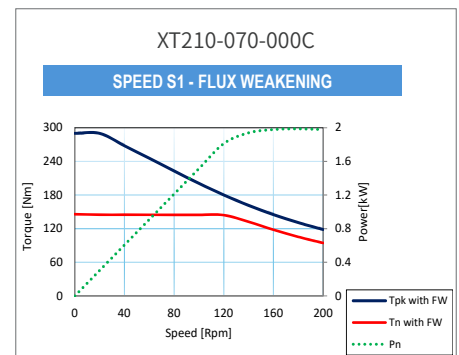
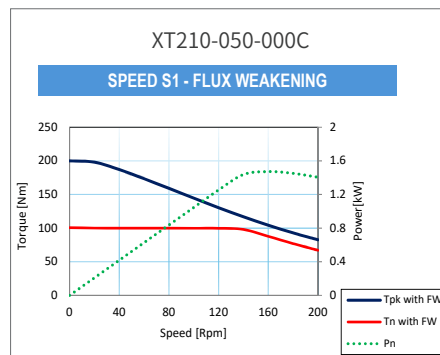
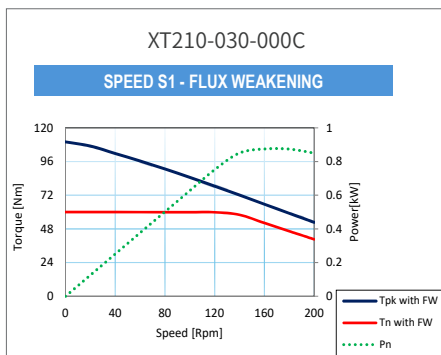

XT210

尺寸参数 Dimensional parameters

电机型号 Motor Code	DS1	DS2	DS3	DR1	DR2	LS1	LR1	L	N1*AS1	N2*AS3	N3*AR1	N4*AR3
XT210-030-000C	230.0	230.0	175.0	173.8	140.0	70.0	30.0	19.5	12*M5	12*M5	12*M5	12*M5
XT210-050-000C	230.0	230.0	175.0	173.8	140.0	90.0	50.0	19.5	12*M5	12*M5	12*M5	12*M5
XT210-070-000C	230.0	230.0	175.0	173.8	140.0	110.0	70.0	19.5	12*M5	12*M5	12*M5	12*M5
XT210-100-000C	230.0	230.0	175.0	173.8	140.0	140.0	100.0	19.5	23*M5	23*M5	24*M5	24*M5
XT210-150-000C	230.0	230.0	175.0	173.8	140.0	190.0	150.0	19.5	23*M5	23*M5	24*M5	24*M5
XT210-200-000C	230.0	230.0	175.0	173.8	140.0	240.0	200.0	19.5	23*M5	23*M5	24*M5	24*M5

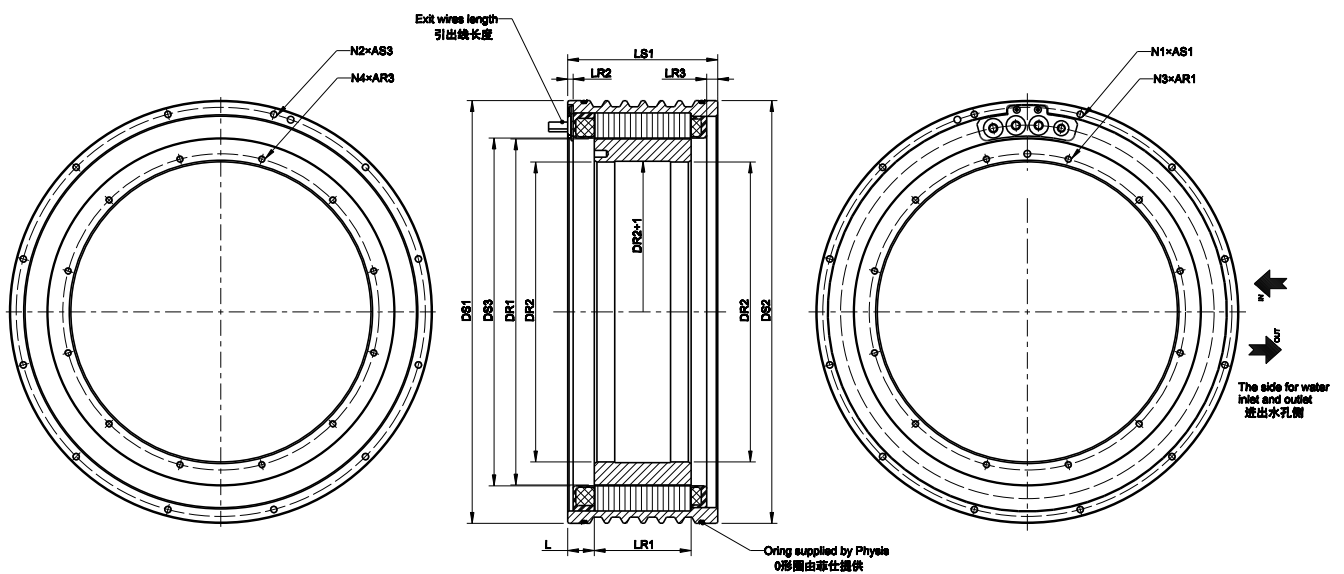

XT295

性能参数 Performance parameters

电机型号 Motor Code	额定转速 wn	峰值转速 wmax	额定电流 In	额定扭矩 Tn	额定功率 Pn	最大电流 Imax	最大转矩 Tmax
	[rpm]	[rpm]	[A]	[Nm]	[kW]	[A]	[Nm]
XT295-030-000C	100	200	6.5	140	1.5	13.0	280
XT295-050-000C	100	200	9.2	250	2.6	21.0	500
XT295-070-000C	100	200	11.7	350	3.7	27.0	700
XT295-100-000C	100	200	18.3	500	5.2	42.0	1000
XT295-150-000C	100	200	23.0	750	7.9	52.3	1500
XT295-200-000C	100	200	34.6	1000	10.5	78.5	2000

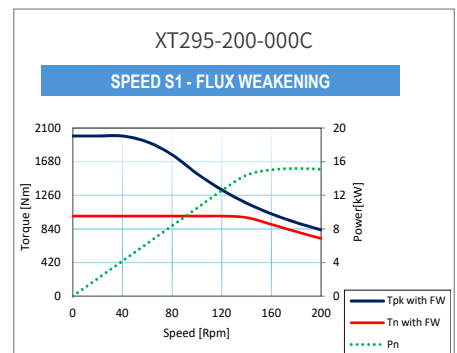
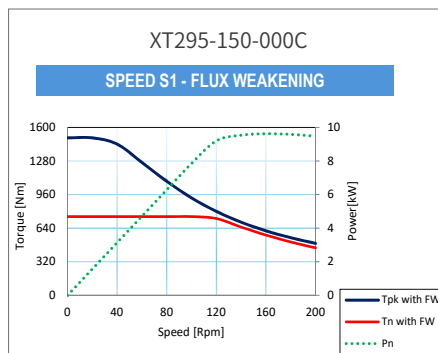
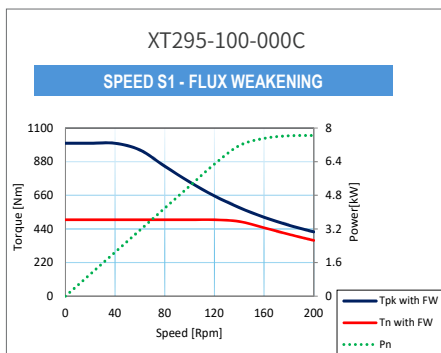
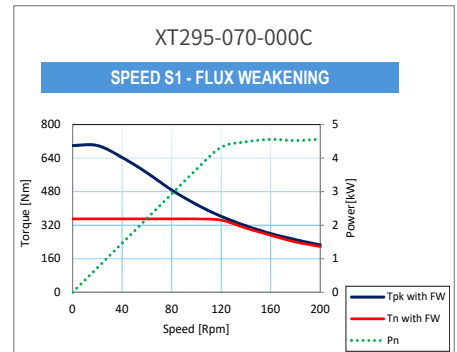
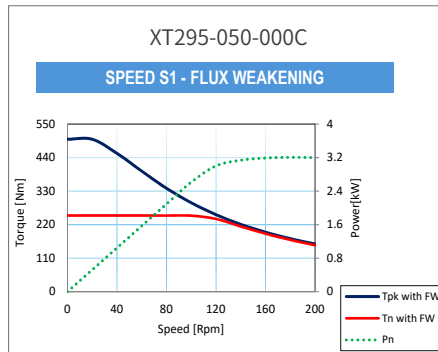
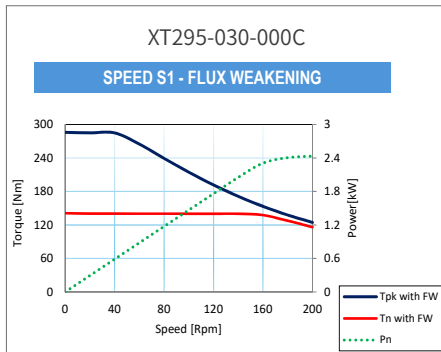

XT295

尺寸参数 Dimensional parameters

电机型号 Motor Code	DS1	DS2	DS3	DR1	DR2	LS1	LR1	L	N1*AS1	N2*AS3	N3*AR1	N4*AR3
XT295-030-000C	310.0	310.0	255.0	253.8	220.0	70.0	30.0	19.5	12*M5	12*M5	12*M5	12*M5
XT295-050-000C	310.0	310.0	255.0	253.8	220.0	90.0	50.0	19.5	12*M5	12*M5	12*M5	12*M5
XT295-070-000C	310.0	310.0	255.0	253.8	220.0	110.0	70.0	19.5	12*M5	12*M5	12*M5	12*M5
XT295-100-000C	310.0	310.0	255.0	253.8	220.0	140.0	100.0	19.5	23*M5	23*M5	24*M5	24*M5
XT295-150-000C	310.0	310.0	255.0	253.8	220.0	190.0	150.0	19.5	23*M5	23*M5	24*M5	24*M5
XT295-200-000C	310.0	310.0	255.0	253.8	220.0	240.0	200.0	19.5	23*M5	23*M5	24*M5	24*M5

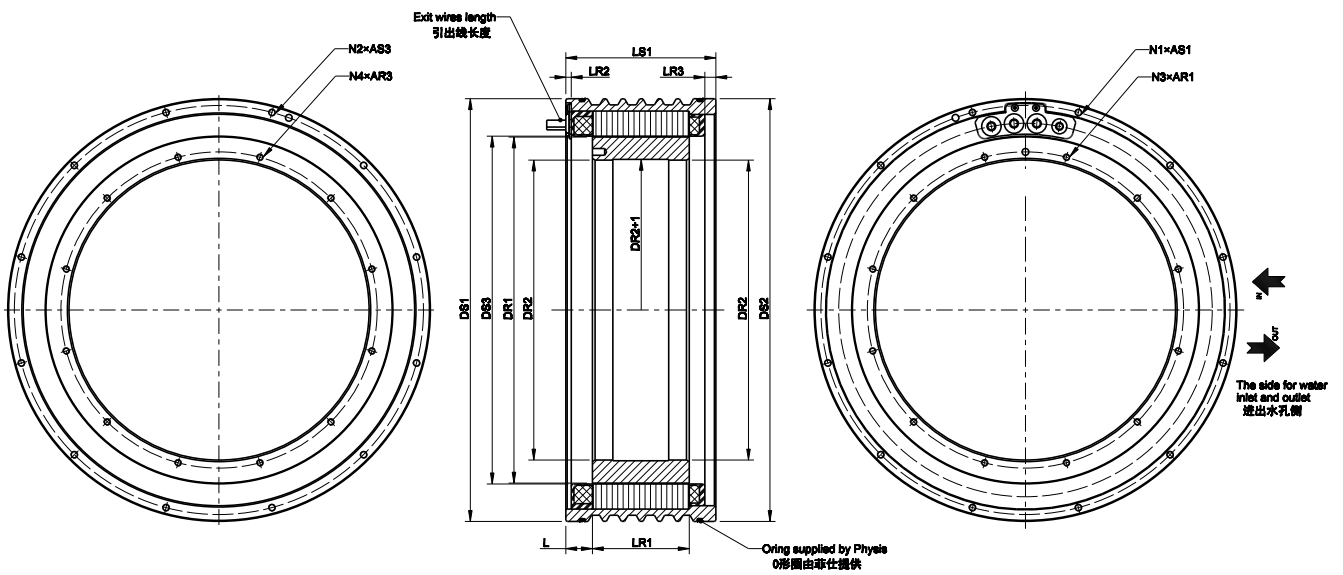

XT360

性能参数 Performance parameters

电机型号 Motor Code	额定转速 wn	峰值转速 wmax	额定电流 In	额定扭矩 Tn	额定功率 Pn	最大电流 Imax	最大转矩 Tmax
	[rpm]	[rpm]	[A]	[Nm]	[kW]	[A]	[Nm]
XT360-030-000C	100	200	9.5	230	2.4	20	450
XT360-050-000C	100	200	12	405	4.2	23.5	740
XT360-070-000C	100	200	20.5	575	6.0	39	1030
XT360-100-000C	100	200	25.3	845	8.9	47	1470
XT360-150-000C	100	200	38.5	1270	13.3	71	2210
XT360-200-000C	100	200	46.5	1700	17.8	88	2950

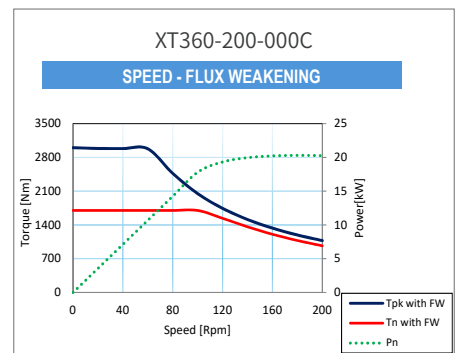
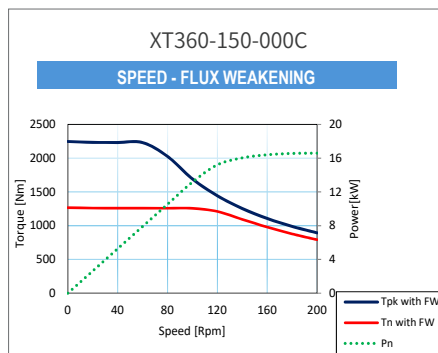
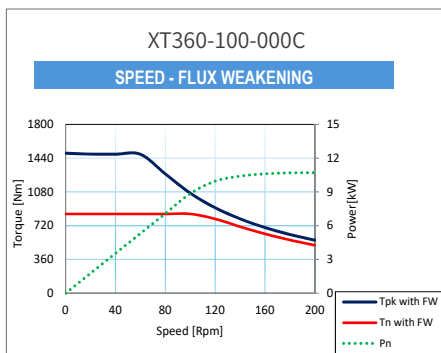
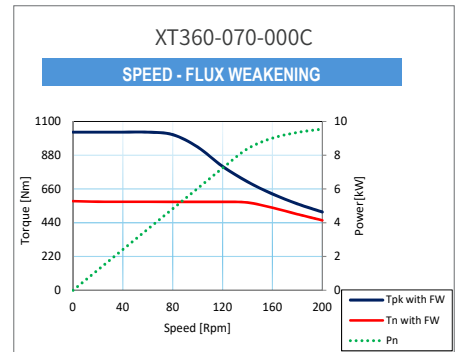
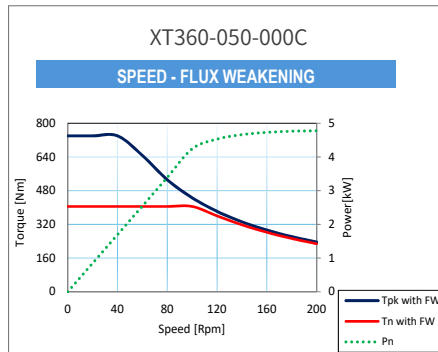
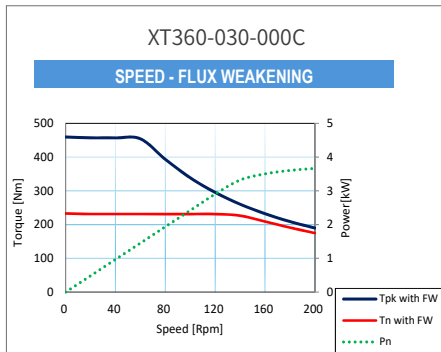

XT360

尺寸参数 Dimensional parameters

电机型号 Motor Code	DS1	DS2	DS3	DR1	DR2	LS1	LR1	L	N1*AS1	N2*AS3	N3*AR1	N4*AR3
XT360-030-000C	385.0	385.0	313.0	311.0	265.0	80.0	30.0	29.5	12*M6	12*M6	12*M6	12*M6
XT360-050-000C	385.0	385.0	313.0	311.0	265.0	100.0	50.0	29.5	12*M6	12*M6	12*M6	12*M6
XT360-070-000C	385.0	385.0	313.0	311.0	265.0	120.0	70.0	29.5	12*M6	12*M6	12*M6	12*M6
XT360-100-000C	385.0	385.0	313.0	311.0	265.0	150.0	100.0	29.5	23*M6	24*M6	23*M6	24*M6
XT360-150-000C	385.0	385.0	313.0	311.0	265.0	200.0	150.0	29.5	23*M6	24*M6	23*M6	24*M6
XT360-200-000C	385.0	385.0	313.0	311.0	265.0	250.0	200.0	29.5	23*M6	24*M6	23*M6	24*M6

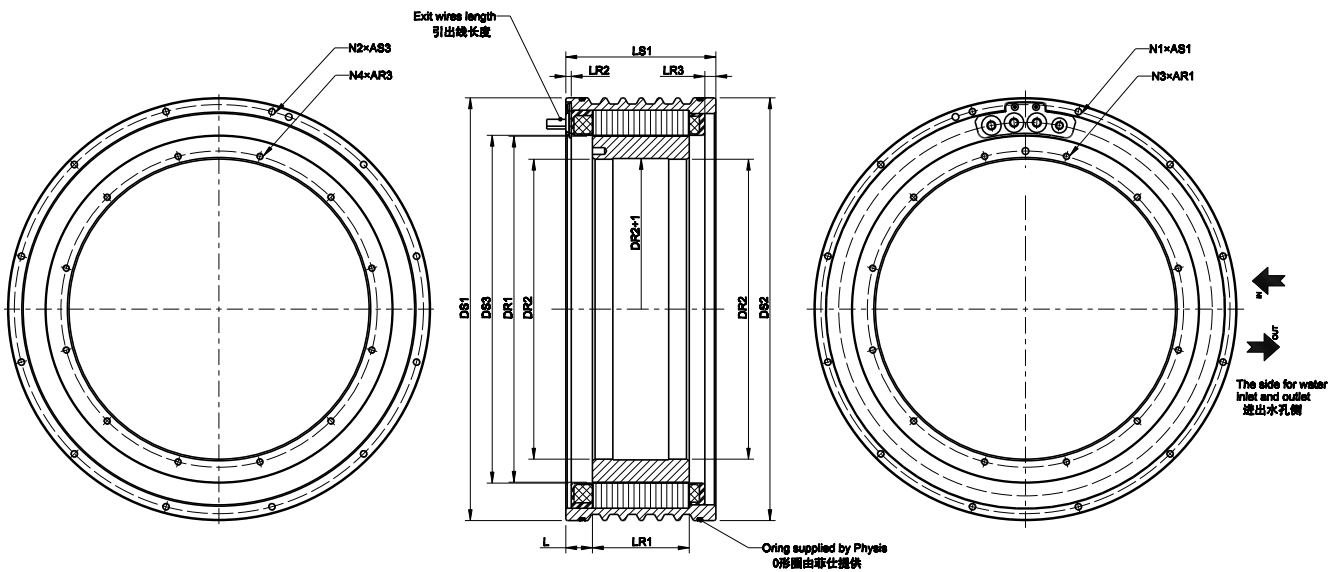

XT450

性能参数 Performance parameters

电机型号 Motor Code	额定转速 wn	峰值转速 wmax	额定电流 In	额定扭矩 Tn	额定功率 Pn	最大电流 Imax	最大转矩 Tmax
	[rpm]	[rpm]	[A]	[Nm]	[kW]	[A]	[Nm]
XT450-030-000C	100	200	15.6	380	4.0	35	710
XT450-050-000C	100	200	25	680	7.1	56	1210
XT450-070-000C	100	200	32	960	10.1	72	1690
XT450-100-000C	100	200	50	1370	14.4	110	2420
XT450-150-000C	100	200	63	2050	21.5	140	3560
XT450-200-000C	100	200	94	2800	29.3	205	4830

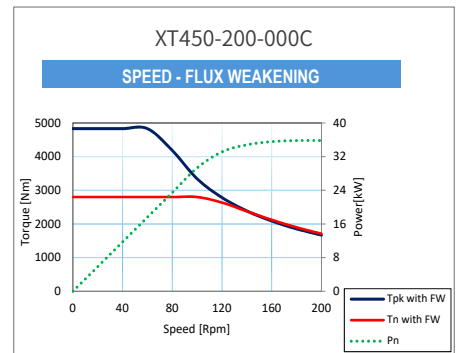
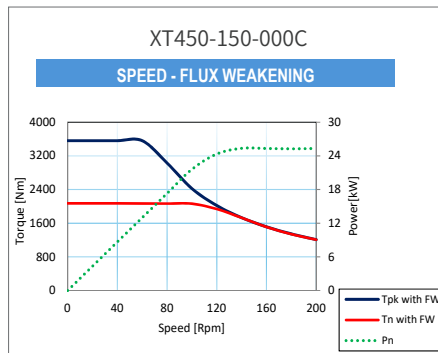
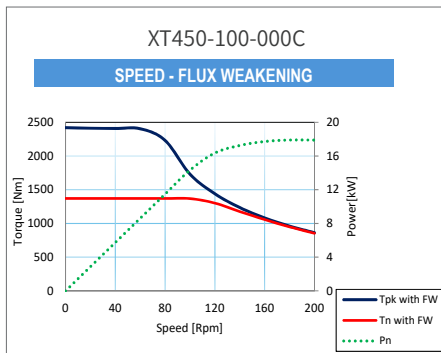
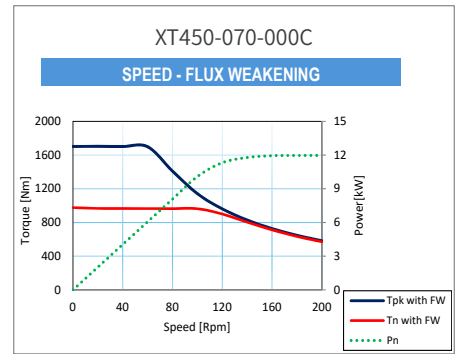
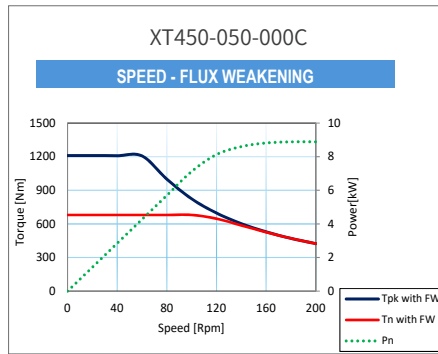
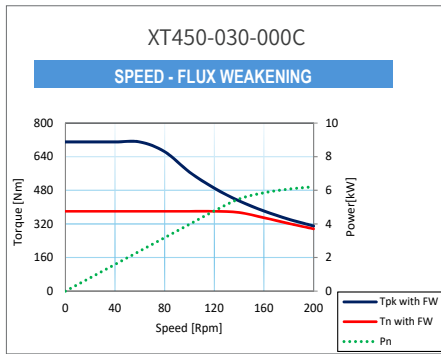

XT450

尺寸参数 Dimensional parameters

电机型号 Motor Code	DS1	DS2	DS3	DR1	DR2	LS1	LR1	L	N1*AS1	N2*AS3	N3*AR1	N4*AR3
XT450-030-000C	485.0	485.0	383.0	382.2	345.0	90.0	30.0	37.5	12*M8	12*M8	12*M8	12*M8
XT450-050-000C	485.0	485.0	383.0	382.2	345.0	110.0	50.0	37.5	12*M8	12*M8	12*M8	12*M8
XT450-070-000C	485.0	485.0	383.0	382.2	345.0	130.0	70.0	37.5	12*M8	12*M8	12*M8	12*M8
XT450-100-000C	485.0	485.0	383.0	382.2	345.0	160.0	100.0	37.5	23*M8	24*M8	23*M8	24*M8
XT450-150-000C	485.0	485.0	383.0	382.2	345.0	210.0	150.0	37.5	23*M8	24*M8	23*M8	24*M8
XT450-200-000C	485.0	485.0	383.0	382.2	345.0	260.0	200.0	37.5	23*M8	24*M8	23*M8	24*M8

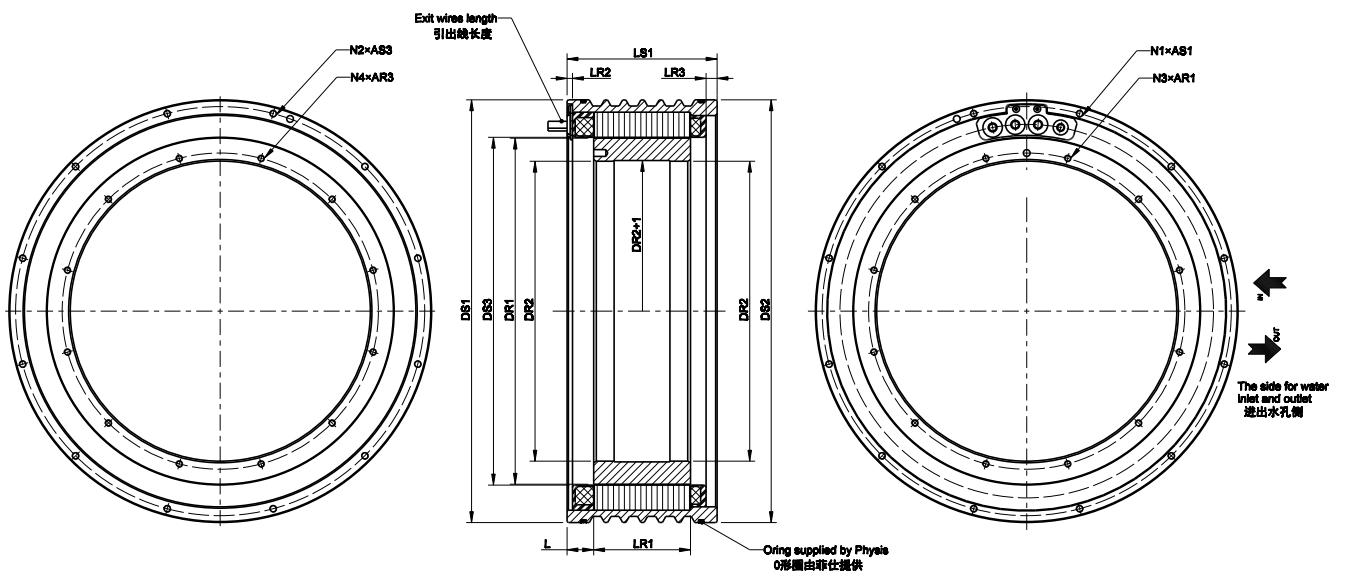

XT530

性能参数 Performance parameters

电机型号 Motor Code	额定转速 w_n	峰值转速 w_{max}	额定电流 I_n	额定扭矩 T_n	额定功率 P_n	最大电流 I_{max}	最大扭矩 T_{max}
	[rpm]	[rpm]	[A]	[Nm]	[kW]	[A]	[Nm]
XT530-050-000C	110	300	26.1	1041	12.0	64.0	1700
XT530-070-000C	75	300	55.0	1538	12.1	124.0	2500
XT530-100-000C	120	350	56.4	2089	26.2	137.0	3500
XT530-150-000C	150	400	57.3	3342	52.5	154.0	5500
XT530-200-000C	110	350	114.8	4459	51.4	278.0	7000

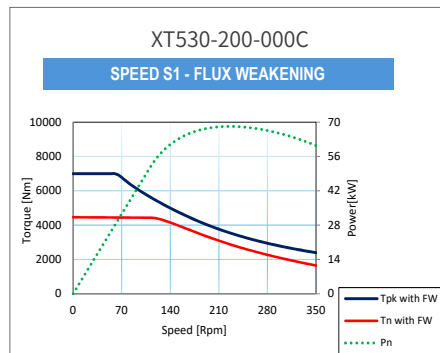
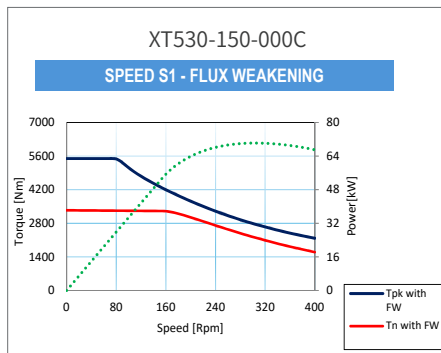
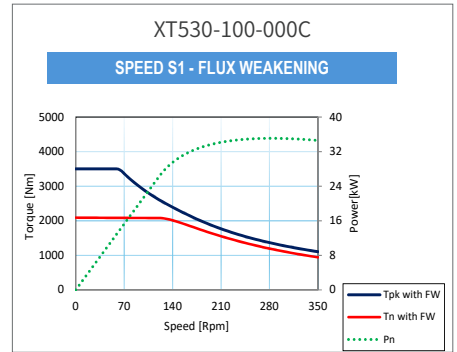
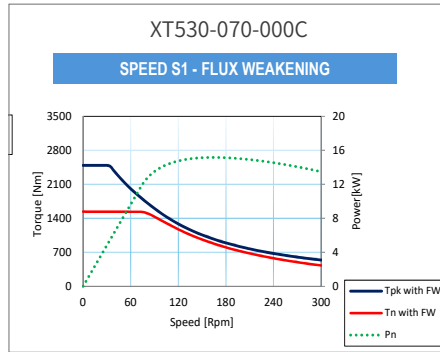
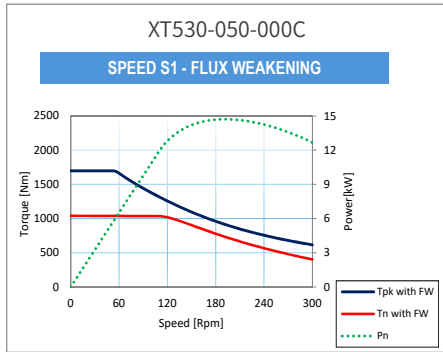

XT530

尺寸参数 Dimensional parameters

电机型号 Motor Code	DS1	DS2	DS3	DR1	DR2	LS1	LR1	L	N1*AS1	N2*AS3	N3*AR1	N4*AR3
XT530-050-000C	565.0	565.0	460.0	457.6	420.0	110.0	50.0	29.5	12*M8	12*M8	12*M8	12*M8
XT530-070-000C	565.0	565.0	460.0	457.6	420.0	130.0	70.0	29.5	12*M8	12*M8	12*M8	12*M8
XT530-100-000C	565.0	565.0	460.0	457.6	420.0	160.0	100.0	29.5	23*M8	23*M8	24*M8	24*M8
XT530-150-000C	565.0	565.0	460.0	457.6	420.0	210.0	150.0	29.5	23*M8	23*M8	24*M8	24*M8
XT530-200-000C	565.0	565.0	460.0	457.6	420.0	260.0	200.0	29.5	23*M8	23*M8	24*M8	24*M8

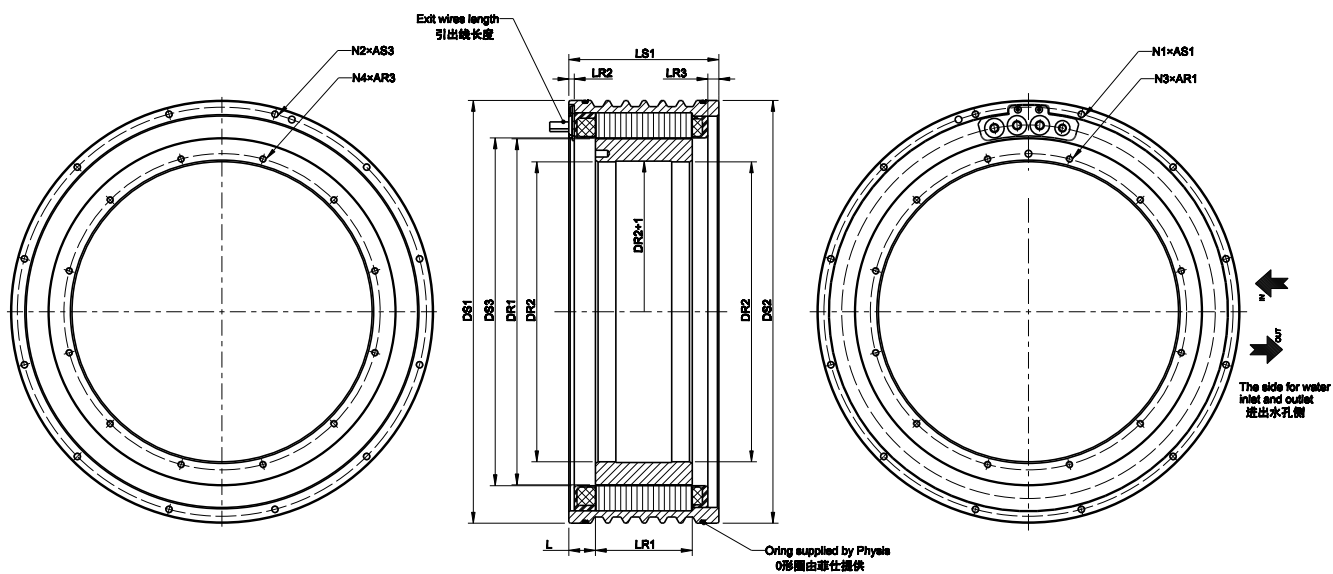

XT760

性能参数 Performance parameters

电机型号 Motor Code	额定转速 wn	峰值转速 wmax	额定电流 In	额定扭矩 Tn	额定功率 Pn	最大电流 Imax	最大扭矩 Tmax
	[rpm]	[rpm]	[A]	[Nm]	[kW]	[A]	[Nm]
XT760-050-000C	105	300	52.1	2156	23.7	164.0	3800
XT760-070-000C	105	300	82.2	3357	36.9	226.0	5500
XT760-100-000C	75	300	84.3	4553	35.8	263.0	7800
XT760-150-000C	115	400	164.1	6507	78.4	415.0	11600
XT760-200-000C	85	300	164.8	8707	77.5	417.0	15500

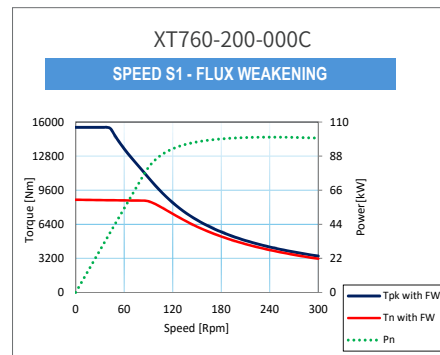
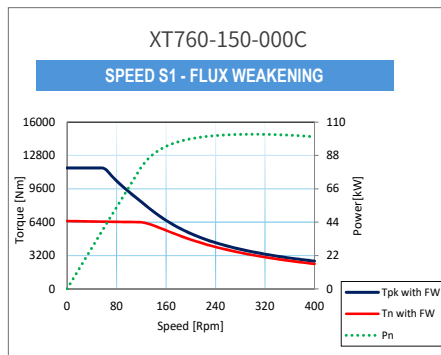
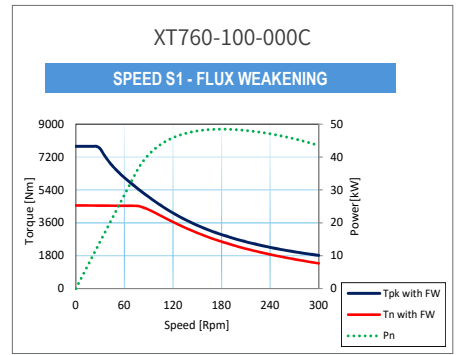
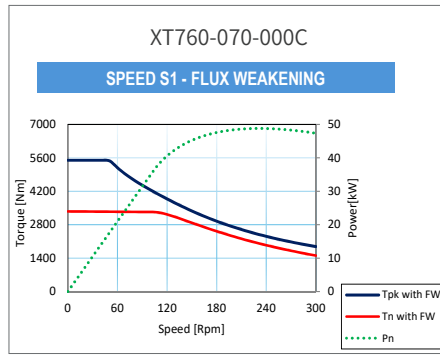
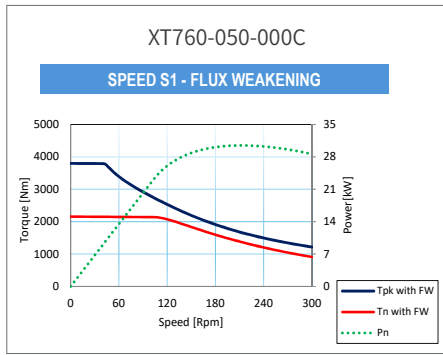

XT760

尺寸参数 Dimensional parameters

电机型号 Motor Code	DS1	DS2	DS3	DR1	DR2	LS1	LR1	L	N1*AS1	N2*AS3	N3*AR1	N4*AR3
XT760-050-000C	795.0	795.0	690.0	687.6	650.0	130.0	50.0	39.5	16*M8	16*M8	16*M8	16*M8
XT760-070-000C	795.0	795.0	690.0	687.6	650.0	150.0	70.0	39.5	16*M8	16*M8	16*M8	16*M8
XT760-100-000C	795.0	795.0	690.0	687.6	650.0	180.0	100.0	39.5	31*M8	31*M8	32*M8	32*M8
XT760-150-000C	795.0	795.0	690.0	687.6	650.0	230.0	150.0	39.5	31*M8	31*M8	32*M8	32*M8
XT760-200-000C	795.0	795.0	690.0	687.6	650.0	280.0	200.0	39.5	31*M8	31*M8	32*M8	32*M8

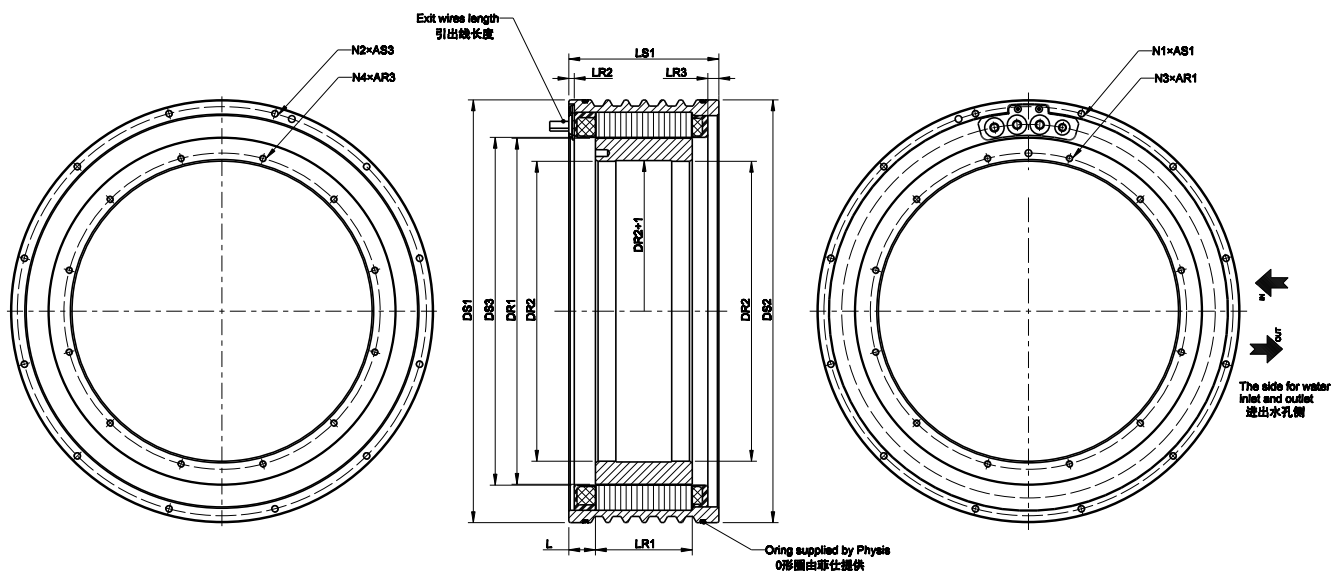

XT990

性能参数 Performance parameters

电机型号 Motor Code	额定转速 w_n	峰值转速 w_{max}	额定电流 I_n	额定扭矩 T_n	额定功率 P_n	最大电流 I_{max}	最大转矩 T_{max}
	[rpm]	[rpm]	[A]	[Nm]	[kW]	[A]	[Nm]
XT990-070-000C	80	200	105.3	5823	48.3	277	9800
XT990-100-000C	125	300	215.3	7894	101.5	629	13800
XT990-150-000C	80	250	218.7	11794	98.1	637	20500
XT990-200-000C	60	200	218.7	15720	95.4	646	27500

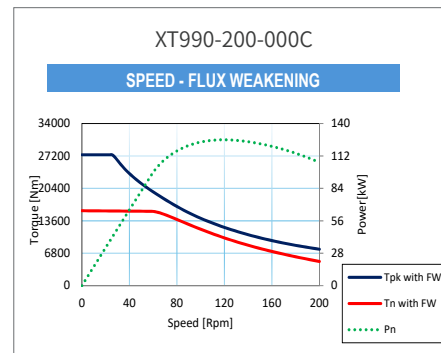
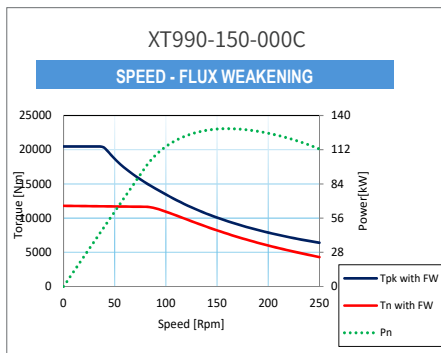
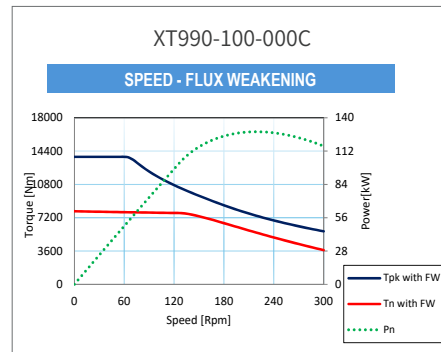
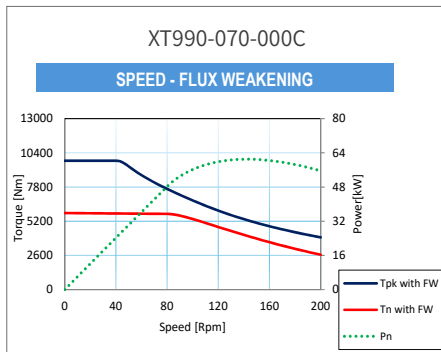

XT990

尺寸参数 Dimensional parameters

电机型号 Motor Code	DS1	DS2	DS3	DR1	DR2	LS1	LR1	L	N1*AS1	N2*AS3	N3*AR1	N4*AR3
XT990-070-000C	1030.0	1030.0	915.0	912.6	870.0	150.0	75.0	39.5	24*M10	24*M10	23*M10	23*M10
XT990-100-000C	1030.0	1030.0	915.0	912.6	870.0	180.0	100.0	39.5	24*M10	24*M10	23*M10	23*M10
XT990-150-000C	1030.0	1030.0	915.0	912.6	870.0	230.0	150.0	39.5	24*M10	24*M10	23*M10	23*M10
XT990-200-000C	1030.0	1030.0	915.0	912.6	870.0	280.0	200.0	39.5	24*M10	24*M10	23*M10	23*M10

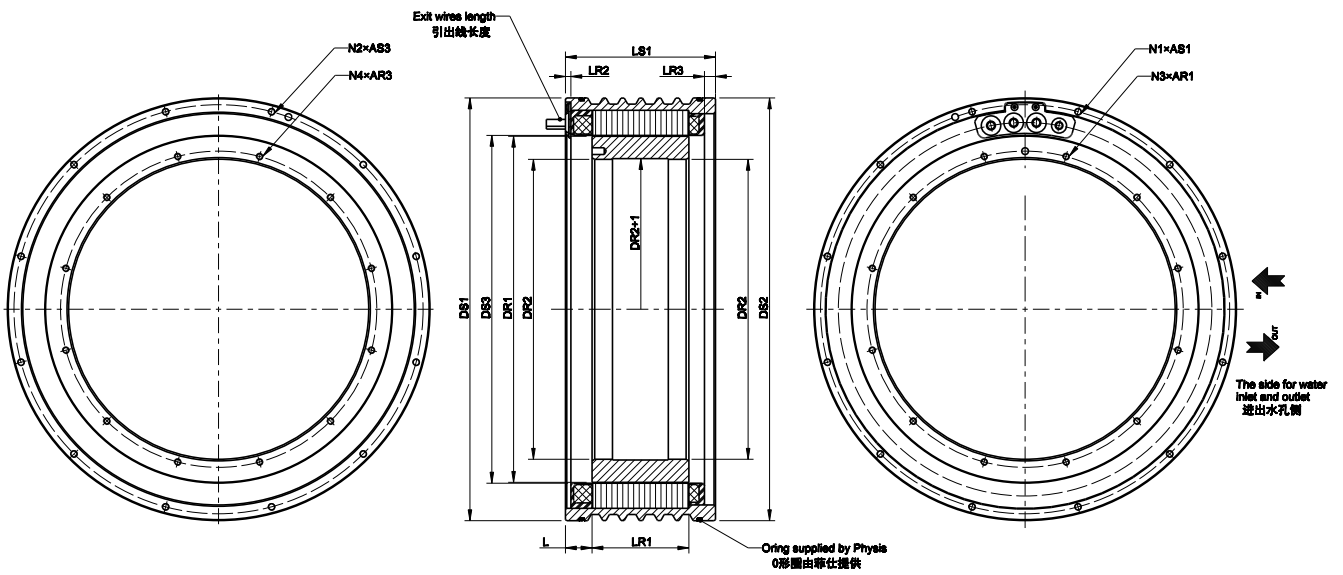

XT1220

性能参数 Performance parameters

电机型号 Motor Code	额定转速 wn	峰值转速 wmax	额定电流 In	额定扭矩 Tn	额定功率 Pn	最大电流 Imax	最大转矩 Tmax
	[rpm]	[rpm]	[A]	[Nm]	[kW]	[A]	[Nm]
XT1220-050-000C	210	500	256.8	6130	128.8	733	10500
XT1220-070-000C	135	400	270.5	9542	131.1	629	15000
XT1220-100-000C	45	200	138.7	12937	60.9	322	20000
XT1220-150-000C	65	250	281.9	19627	128.1	793	32000
XT1220-200-000C	45	200	282	26171	124.6	790	42600

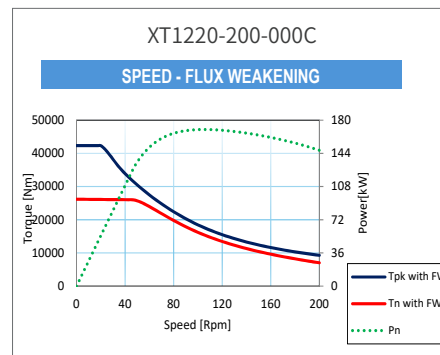
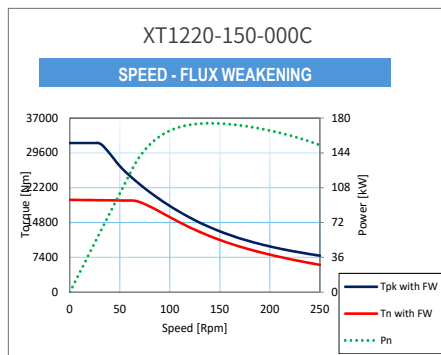
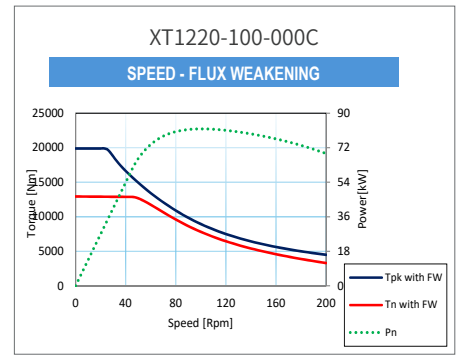
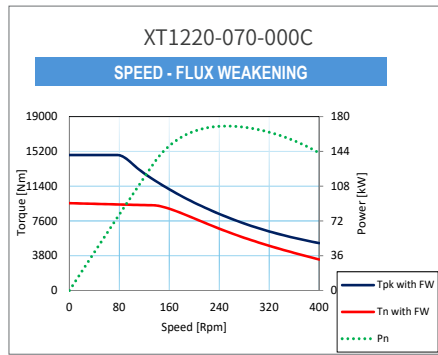
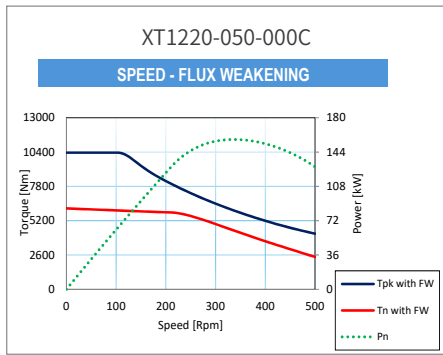

XT1220

尺寸参数 Dimensional parameters

电机型号 Motor Code	DS1	DS2	DS3	DR1	DR2	LS1	LR1	L	N1*AS1	N2*AS3	N3*AR1	N4*AR3
XT1220-050-000C	1290.0	1288.0	1150.0	1147.6	1070.0	110.0	50.0	39.5	46*M10	48*M10	48*M10	48*M10
XT1220-070-000C	1290.0	1288.0	1150.0	1147.6	1070.0	130.0	75.0	39.5	46*M10	48*M10	48*M10	48*M10
XT1220-100-000C	1290.0	1288.0	1150.0	1147.6	1070.0	160.0	100.0	39.5	46*M10	48*M10	48*M10	48*M10
XT1220-150-000C	1290.0	1288.0	1150.0	1147.6	1070.0	210.0	150.0	39.5	46*M10	48*M10	48*M10	48*M10
XT1220-200-000C	1290.0	1288.0	1150.0	1147.6	1070.0	260.0	200.0	39.5	46*M10	48*M10	48*M10	48*M10

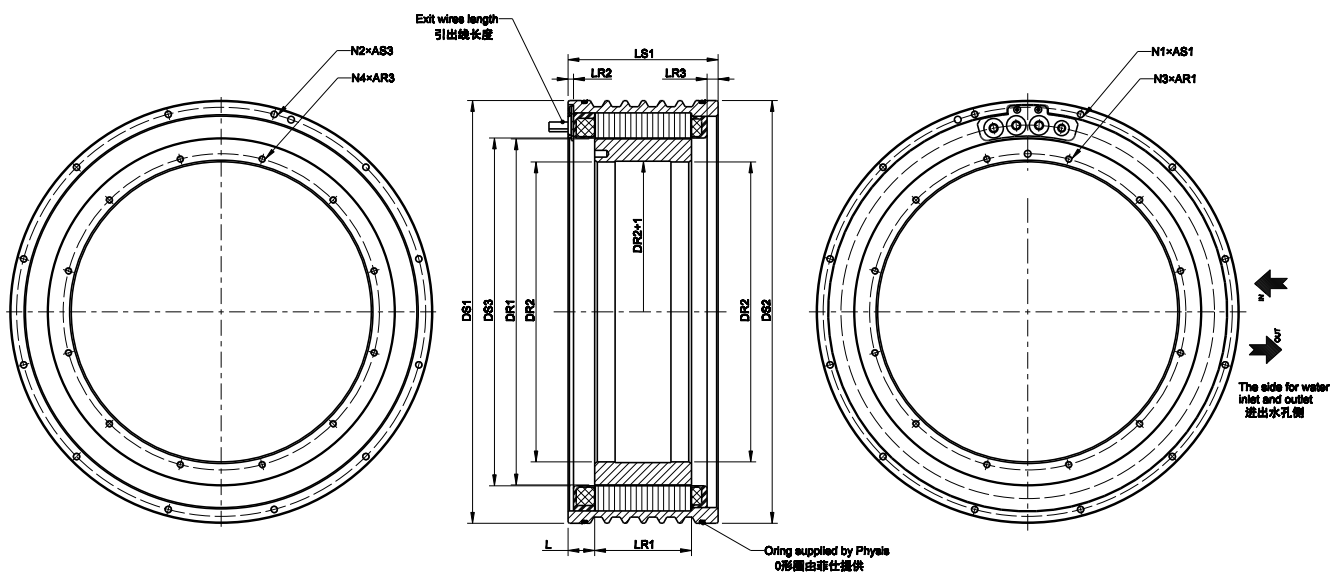

菲仕总部 PHYSIS HEADQUARTER

宁波菲仕技术股份有限公司

Ningbo Physis Technology Co., Ltd.

浙江省宁波市北仑区小港安居路 308 号

No.308, Xiaogang Anju Road, Beilun District, Ningbo, China

总台热线 /Tel: +0086-(0)574-26922600

国内业务 Domestic Sales

销售热线 /Tel: +0086-(0)574-23459197

邮箱 /E-mail: Sales@physis.com.cn

海外业务 Overseas Sales

销售热线 /Tel: +0086-(0)574-23459168

邮箱 /E-mail: OverseaSales@physis.com.cn

售后服务 After Sales

服务热线 /Tel: +0086-(0)574-23459183

邮箱 /E-mail: Aftersales@physis.com.cn



扫一扫了解更多

版本编号: PHMC2403-V01

由于产品的不断更新和改进,本产品型录中的部分产品数据信息会产生变化,为了能提供更好的服务,建议您在查阅本产品型录的同时,请联系我们,以便您及时获得最新的资讯。

All technical data, drawings and product information contained here may be subject to change, in order to provide you with a continuously improved products, please contact with us for up to date information.

